

NSW 50 Orchardleigh Street, Yennora NSW, Australia 2161  
 NEWCASTLE UNIT 3, 82 Mitchell Road, Cardiff (Newcastle), Australia 2285  
 QLD 181 - 185 Cobalt Street, Carole Park QLD, Australia 4300  
 VIC 71 - 73 Mafra Street, Coolaroo VIC, Australia 3048  
 SA 25 Circuit Court, Hendon SA, Australia 5014

Tel: (02) 9892 3188 Fax: (02) 9892 2167  
 Tel: (02) 4956 7878 Fax: (02) 4954 6161  
 Tel: (07) 3271 2877 Fax: (07) 3271 2284  
 Tel: (03) 9302 3366 Fax: (03) 9302 3966  
 Tel: (08) 8445 9002 Fax: (08) 8445 9003

Date \_\_\_\_\_ Order No. \_\_\_\_\_ Date Required \_\_\_\_\_ Contact \_\_\_\_\_ Phone \_\_\_\_\_ Fax \_\_\_\_\_

Customer \_\_\_\_\_

Invoice Address \_\_\_\_\_

Slat Profile Required

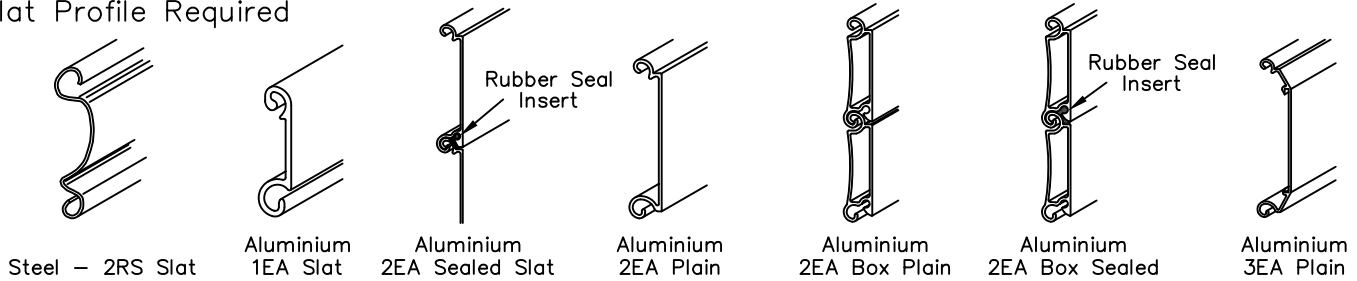

Types of Lock

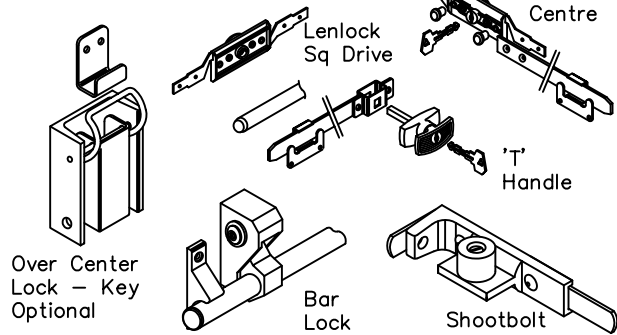

Head Seals  
Optional Extras

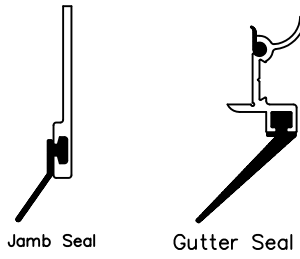

Bracket Types

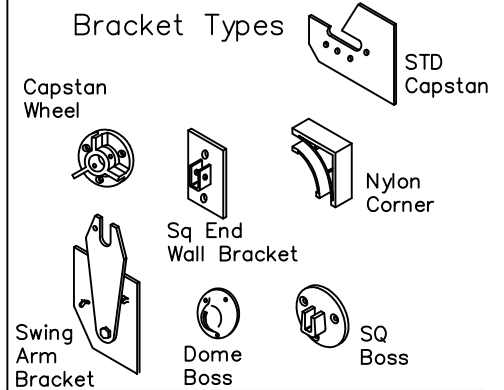

Shutter Type Required

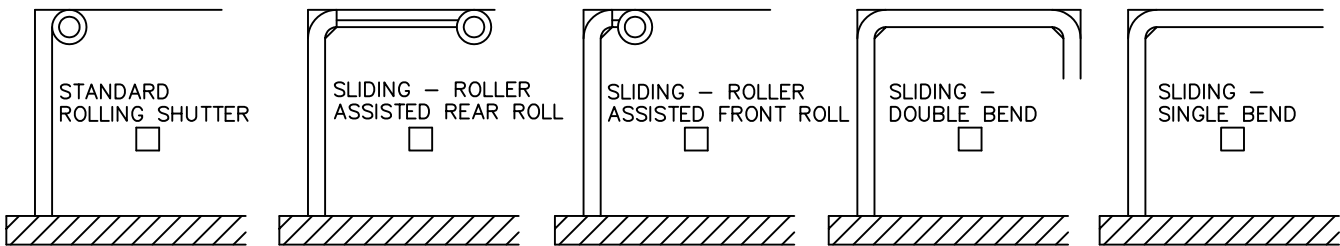

Opening Details

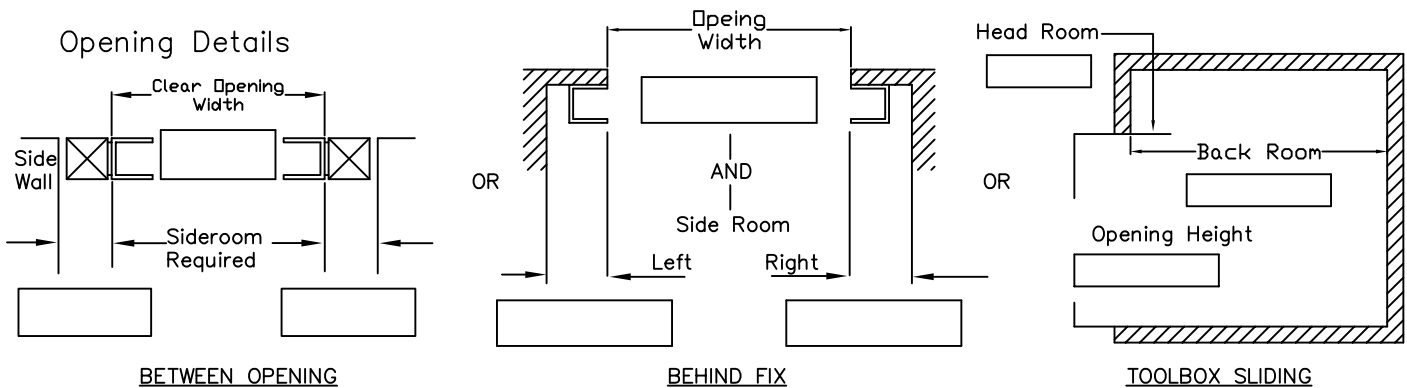

Guide Type

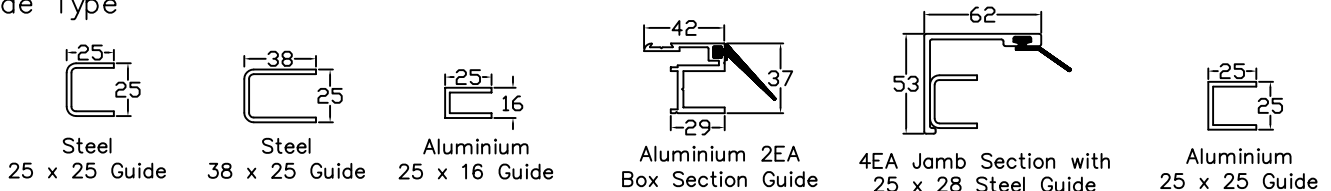

Finish Required

Galvanised  Mill Finish  Anodised Etch & Clear  Anodised Colour  Powder Coat Colour

Requirements

Door Quantity \_\_\_\_\_ Extras \_\_\_\_\_